

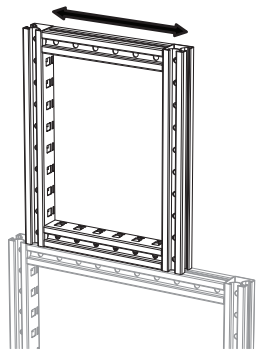

1

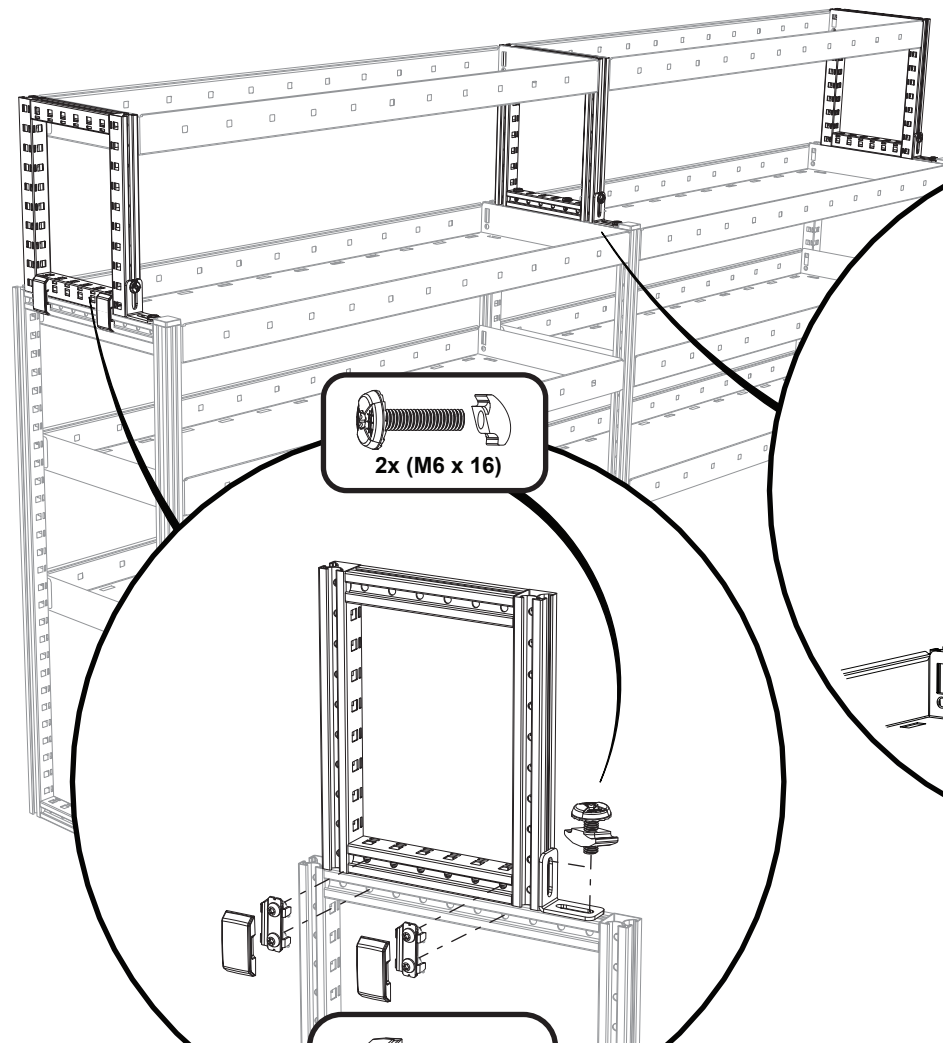



2



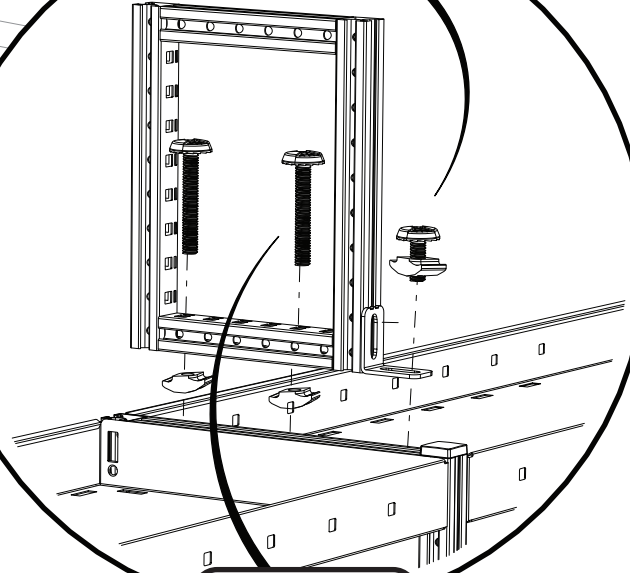

2x (M6 x 16)

2x (M6 x 16)

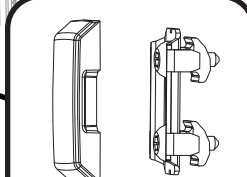

2x (M6 x 40)

2x